

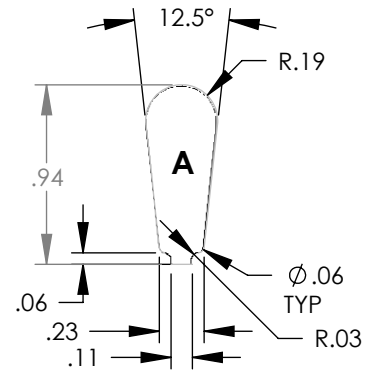

"MADE IN THE USA"

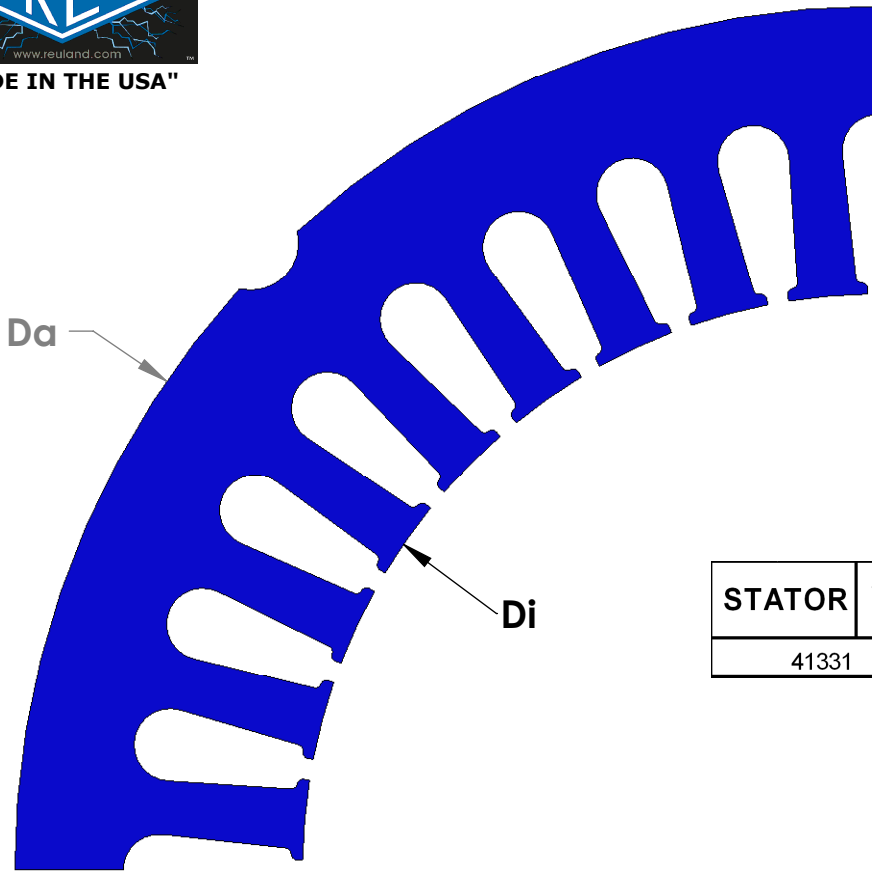

STATOR	SLOT A	CHARACTERISTICS			
		D <sub>a</sub>	D <sub>i</sub>	N	A
41331		9.00	6.00	36	0.262

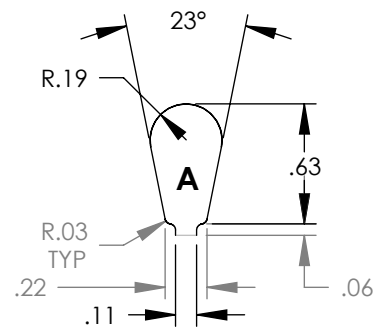
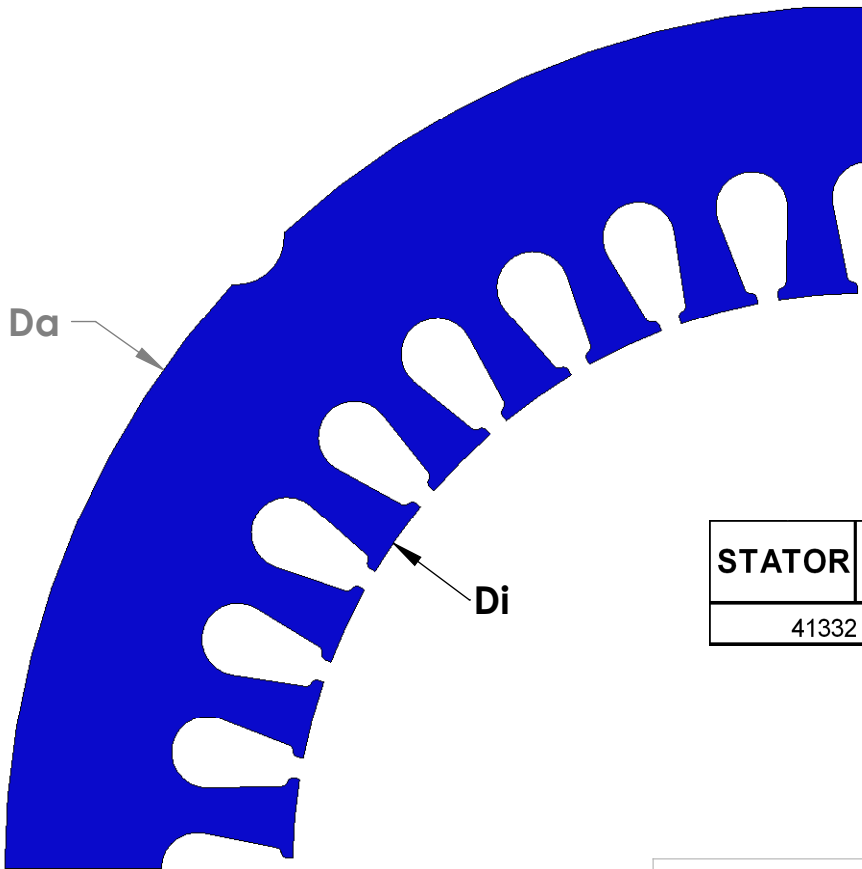

STATOR	SLOT B	CHARACTERISTICS			
		D <sub>a</sub>	D <sub>i</sub>	N	A
41332		9.00	6.00	36	0.183

NOTE: CORES ARE WELDED  
NOT TO SCALE

MATERIAL: SILICON STEEL  
DIMENSIONS: INCHES

**REULAND ELECTRIC CO.**  
INDUSTRY, CA HOWELL, MI CINCINNATI, OH